



STUDIO

Glide®

DESIRABLE.

SCALABLE. DURABLE.

STUDIOGLIDE® BI-FOLD DOORS

# MINIMAL SIGHT LINES, MAXIMUM PERFORMANCE & FLEXIBILITY

## HIGH PERFORMANCE & CONTEMPORARY STYLING THAT LETS MORE OF THE OUTDOORS IN.

The fashion for bi-fold doors shows no sign of slowing down. Why would it, when it offers all that extra natural light the whole year round and the added advantage of throwing open a 'glass wall' to let the outside in during the summer months?

So to give you even more of that bi-fold 'wow' factor we've introduced the StudioGlide® bi-fold system.

## ADVANCED DESIGN THAT'S BETTER ALL ROUND.

With so many options and configurations to choose from, StudioGlide® meets your needs exactly. Dual colour and multiple threshold options. Double or triple glazing... the choice is practically limitless.

Not to mention, of course, the improved sight lines, increased door sizes and slimmer profiles that come as standard with this breakthrough bi-fold design.

All easily fabricated and quick to install with a full 10-year guarantee against warping and frame failure for your complete peace of mind.



STUDIO

Glide®

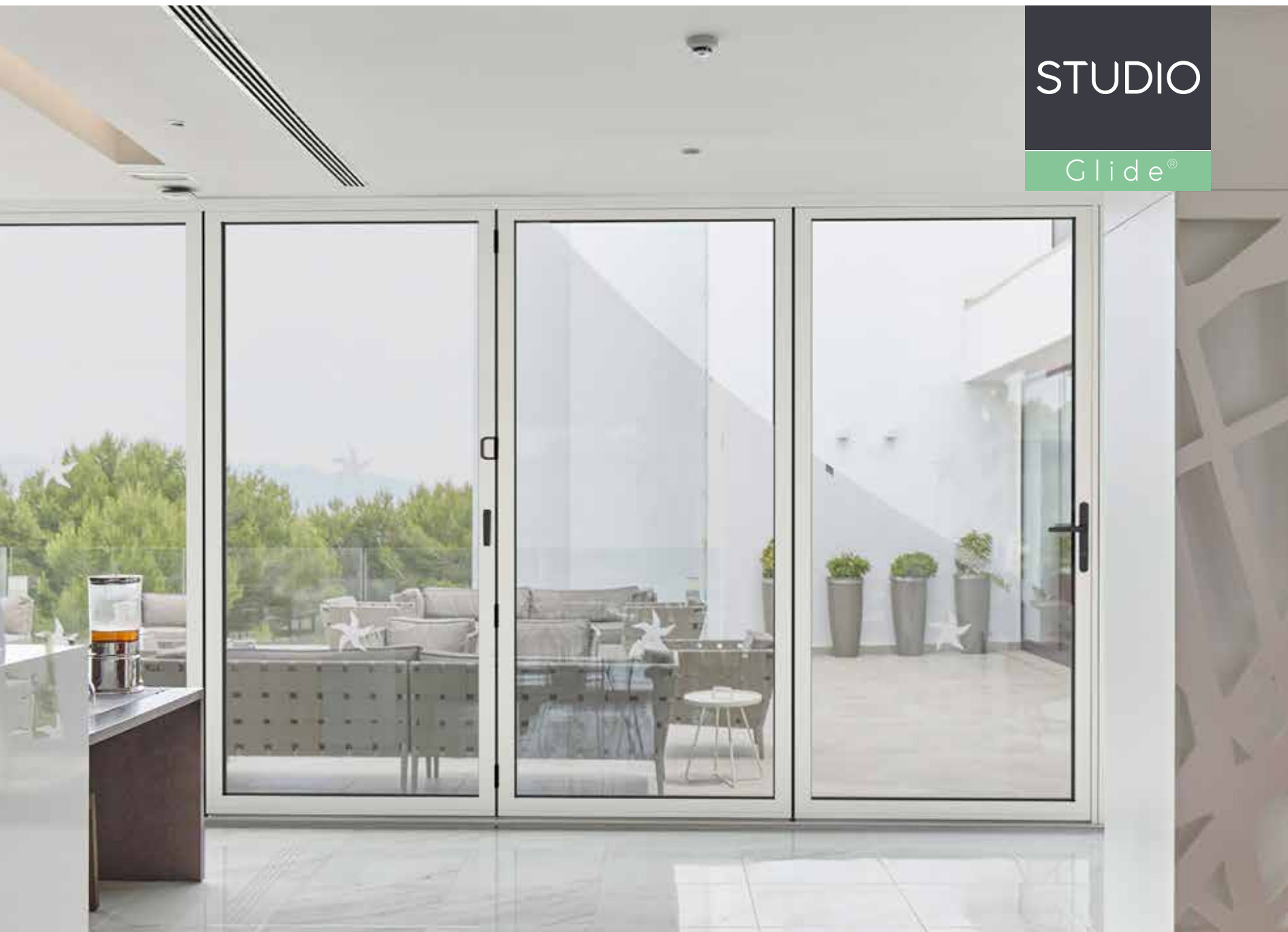



# WHY CHOOSE STUDIOGLIDE®?





### PEACE OF MIND

10-year guarantee.  
Tested to BS6375 2015.  
PAS 24 accredited for security

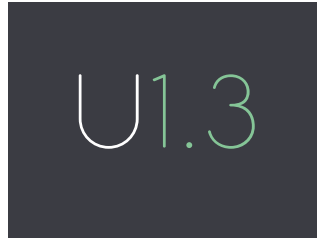

### ENVIRONMENTAL PERFORMANCE

U-values as low as 1.6W/m<sup>2</sup>k  
for double glazing and  
1.3 W/m<sup>2</sup>k for triple glazing

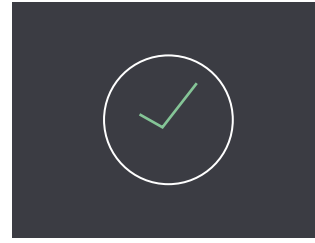

### FAST & ACCURATE

Fast and accurate fabrication  
and installation

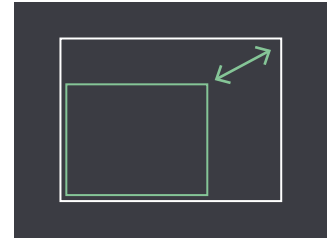

### INCREASED SCALABILITY

Endless possibilities with a  
maximum frame height of 2.5m and  
width of 6.5m and individual sashes  
that can be up to 1.2m wide

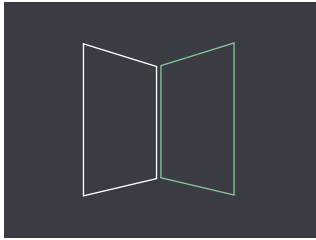

### FLEXIBILITY

Doors can open in or out using the  
same profiles and option for external  
access on any configuration. Low  
threshold option for room dividers

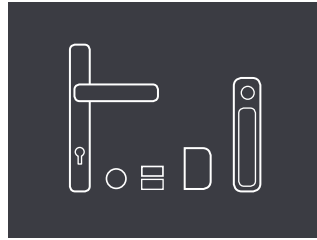

### BESPOKE DESIGNS

Complete range of handles and  
accessories to create bespoke bi-fold  
designs including colour matched  
handles and magnetic door holders

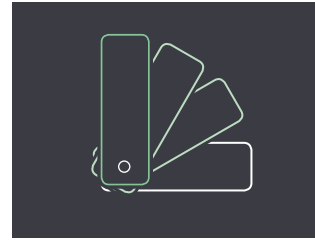

### COLOUR OPTIONS

Colour options that complement  
the aesthetic of any property,  
including a duo colour option

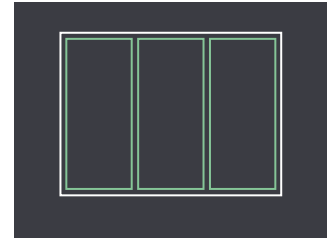

### MINIMAL SIGHT LINES

Minimal profiles for a modern look  
and inline system with sash and outer  
frame of the same depth

## THE HIGH-PERFORMANCE ALUMINIUM BI-FOLD.

StudioGlide® isn't just a winning combination of high performance and thermal efficiency.

Quality materials and advanced design make for a smooth, reliable sliding mechanism and frames that won't expand or contract, whatever extremes the weather throws at them.

Temperatures indoors are kept comfortable too, with a thermal break in the frame that reduces heat loss and high-spec energy efficient glass to reduce energy bills even further.

# A PRODUCT OF INTELLIGENT DESIGN

StudioGlide® has been developed for use in a wide range of domestic and commercial properties. Whatever you use it for, its flexibility and versatility make it the ideal choice.

Clever features like doors that can be fitted to open inward or outwards using the same profile make life easier at the planning stage and during installation.

There's a choice of 'fully weathered' or 'low level' thresholds, complete with integrated locking solutions. Even an adjustable jamb that lets you make fine adjustments to get the perfect fit.

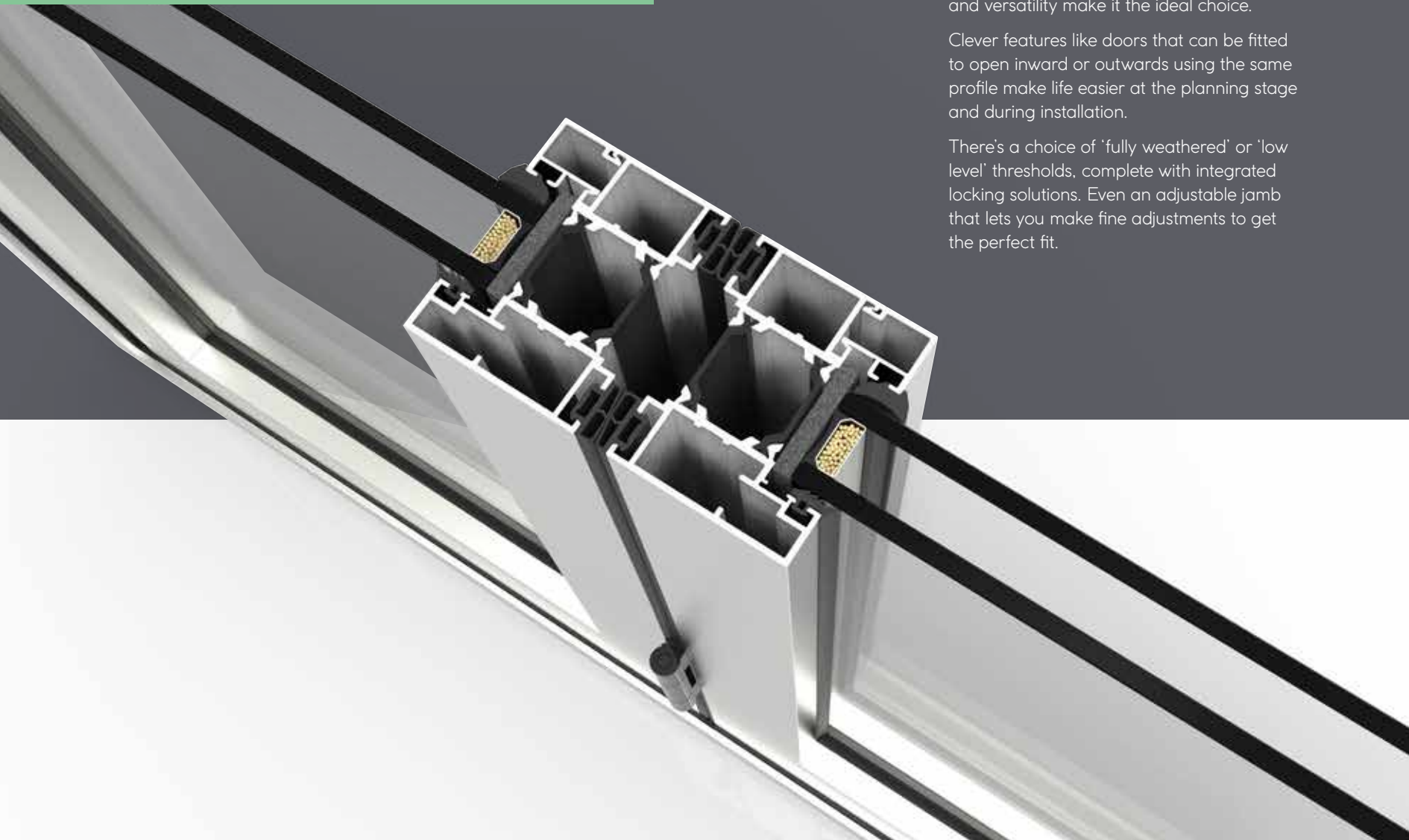





### GLAZING THAT'S CLEARLY BETTER.

StudioGlide® is glazed from the inside for increased security, using purpose designed gaskets to get the best possible seal against the weather. StudioGlide® can take double or triple glazing, with folding sashes accepting 28mm double or 44mm triple glazed units.

### THE SECURE CHOICE.

It might be designed to let the outside in, but not much else gets past StudioGlide®. That's thanks to industry leading security features that give you all the peace of mind that comes with full PAS 24 accreditation.



# CLASSIC COLOURS TO FRAME THE VIEW

## 10-YEAR GUARANTEE.

StudioGlide® bi-fold door profiles and door furniture are guaranteed for ten years. That means you get all the assurance of a robust, well-designed, precision-made product that's built to last.





StudioGlide® frames are available in a range of classic colours, complemented by shootbolt and door handles in a wide choice of colours and finishes.

#### STANDARD FRAME COLOUR OPTIONS

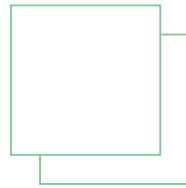

WHITE EXTERIOR  
& INTERIOR

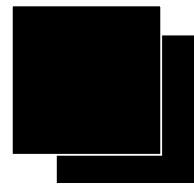

BLACK EXTERIOR  
& INTERIOR



ANTHRACITE  
GREY EXTERIOR  
& INTERIOR



ANTHRACITE  
GREY EXTERIOR  
& WHITE INTERIOR

#### DUO COLOUR OPTION



#### HARDWARE COLOUR OPTIONS

##### SHOOTBOLT HANDLES

(AVAILABLE WITH OR WITHOUT ESCUTCHEON)



WHITE



BLACK



ANTHRACITE  
GREY



BRUSHED  
SATIN



CHROME

##### DOOR HANDLES



WHITE



BLACK



ANTHRACITE  
GREY



BRUSHED  
SATIN



CHROME

# STUDIOGLIDE® BI-FOLD DOOR

## CONFIGURATIONS

The great thing about the StudioGlide® bi-fold system is the sheer choice and flexibility it brings to door design.

All options are available, with inward or outward opening doors, extra leaves, additional configurations and a choice of contemporary colours to create a customised 'glass wall' up to a width of 6.5 metres.

Open outward door combination shown.  
All options are also available inward opening



TOTAL NUMBER OF SASHES **3** **1** **2** SASHES OPENING TO THE RIGHT  
SASHES OPENING TO THE LEFT

## DOOR CONFIGURATION OPTIONS

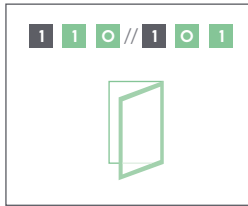

ENTRANCE DOORS

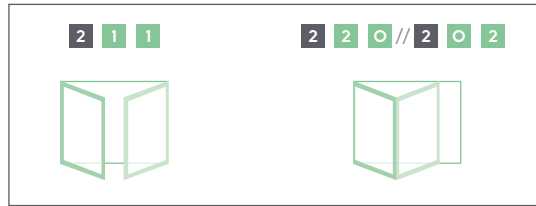

TWO SASH

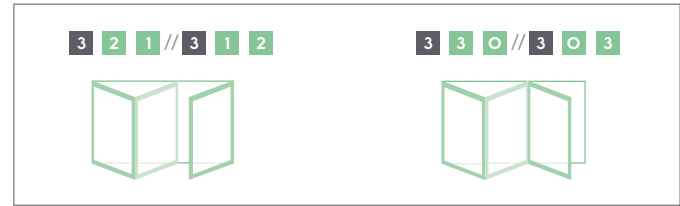

THREE SASH

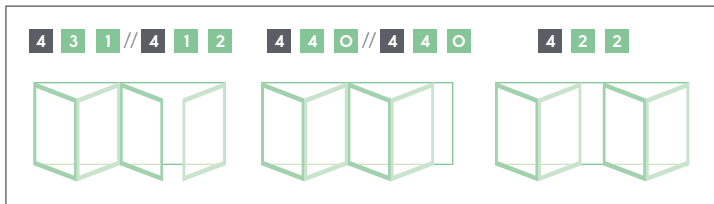

FOUR SASH

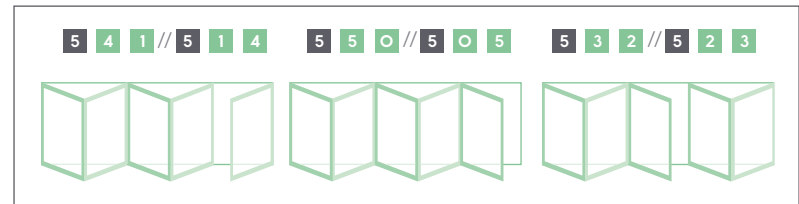

FIVE SASH

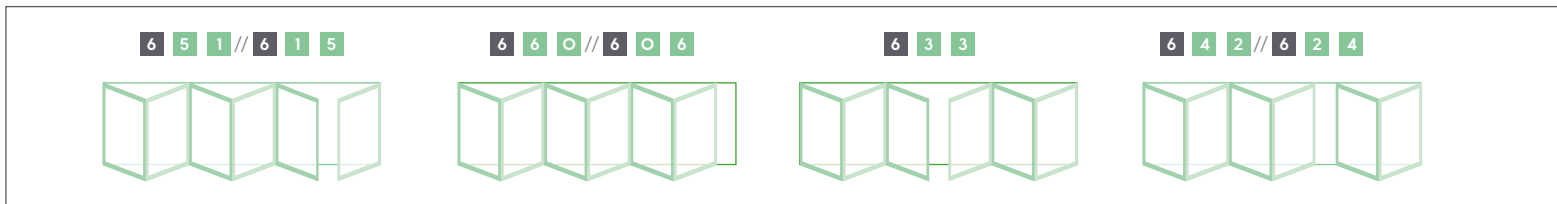

SIX SASH

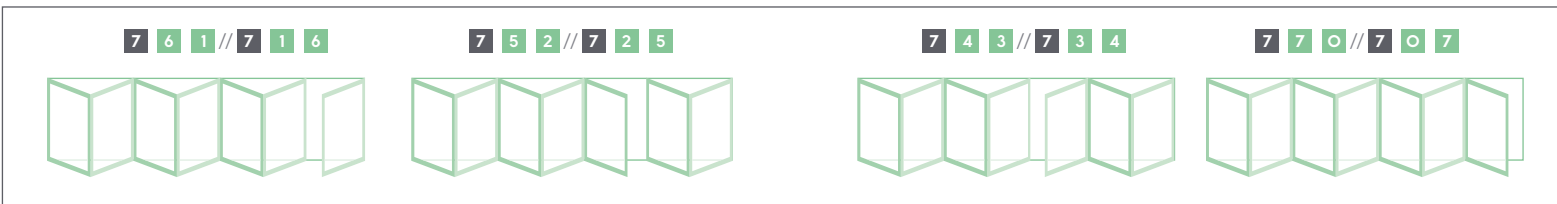

SEVEN SASH

**Please note:** The maximum number of sashes recommended going one way is 7. This is because of the amount of force needed to fully open 7 fully glazed sashes. The width and height of doors are always subject to site conditions allowing for wind loads, locations and use.



# MATERIALS & FINISHING

## SPECIFICATION

### ALUMINIUM EXTRUSION.

Aluminium alloy 6063 T5/T6 to BS/EN12020-2:2008. Extruded surface anodising quality.

### POWDER COATING.

Polyester powder coating to BS/EN 12206-1:2004. 40 microns minimum thickness.

### ANODISING.

Anodic coatings in natural colours. Anodising to BS3987:1991.AA25.

### GLAZING.

StudioGlide® doors are designed for 28mm double glazed or 44mm triple glazing units are possible with bead and gasket changes.

### GASKETRY.

EPDM rubber to BS7412:2007, BS4255-1:1986. 70 SHORE A.

### WEATHERPILES.

Nylon or PVC backed fin-pile and wool-pile draught seals to BS7386:1997.



## SIZES & WEIGHTS.

- A** Maximum overall height = 2500mm
- B** Maximum overall width = 6500mm
- C** Maximum sash width = 1200mm
- D** Maximum sash height = 2384mm
- E** Maximum sash weight = 120kg

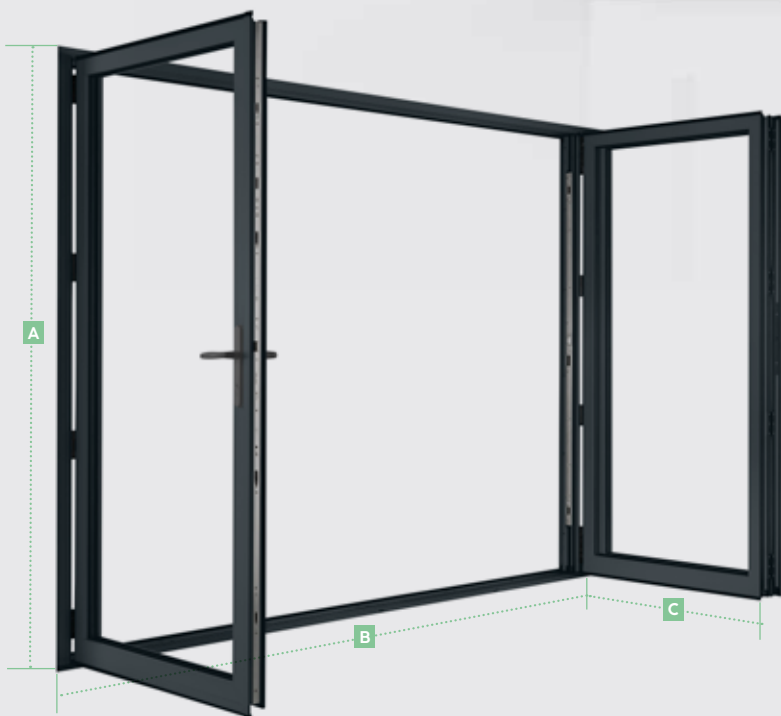

### CROSS SECTIONS

#### 3-2-1 OPEN OUT HORIZONTAL CROSS SECTION

INSIDE

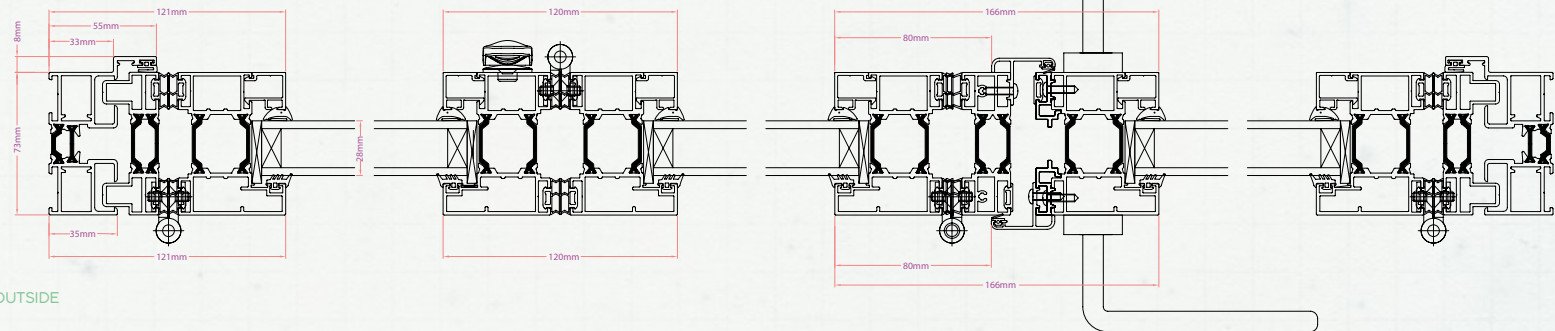

OUTSIDE

#### 3-3-O OPEN OUT HORIZONTAL CROSS SECTION

INSIDE

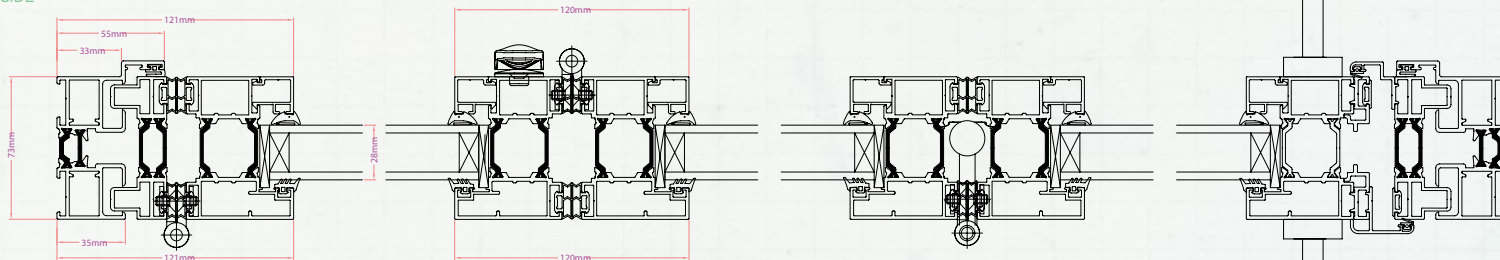

OUTSIDE



# THRESHOLDS

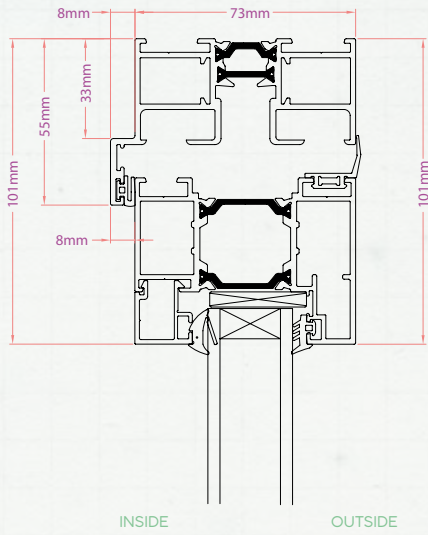

STANDARD THRESHOLD



LOW THRESHOLD

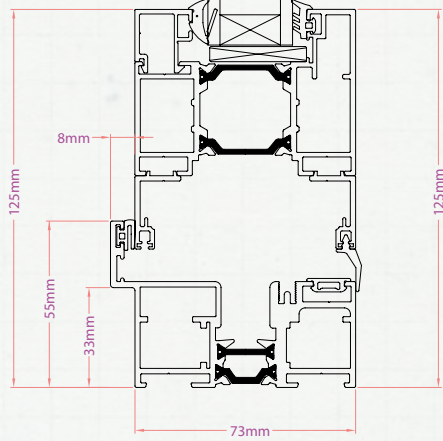

STANDARD THRESHOLD

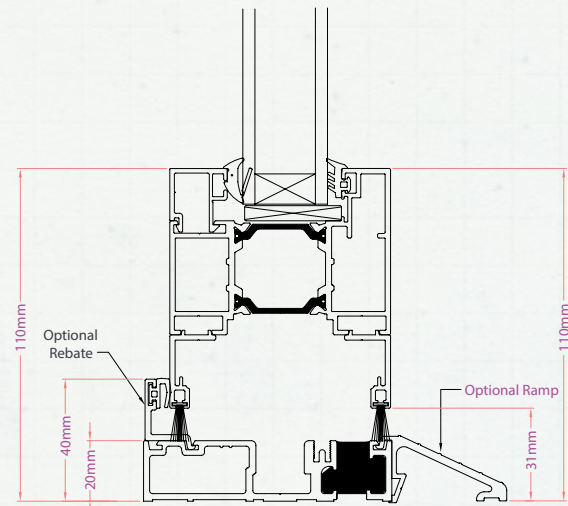

LOW THRESHOLD  
(WITH OPTIONAL RAMP & REBATE)



YOUR AUTHORISED SUPPLIER:

For more information about the **NEW** StudioGlide® bi-fold door system,  
call our customer services team on **0800 988 7317** or visit **studioglide.co.uk**

Product specification is subject to change without notification.  
Please also note that colours shown are illustrative only, as the printing  
process does not allow 100% accurate colours to be reproduced.

A **Eurocell Group** Brand

